



## Magnetic Level Switches for Liquids



measuring  
•  
monitoring  
•  
analysing

### KIT-S1



- Switch points: max. 4
- $p_{\max}$ : 50 bar;  $t_{\max}$ : 180 °C
- Connection:  
Gas parallel, Gas conical, NPT
- Material:  
Stainless steel, brass, PVC, PP, PVDF
- ATEX-Certification

11



KOBOLD companies worldwide:

ARGENTINA, AUSTRIA, BELGIUM, BULGARIA, CANADA, CHILE, CHINA, COLOMBIA, CZECHIA, EGYPT, FRANCE, GERMANY, GREAT BRITAIN, HUNGARY, INDIA, INDONESIA, ITALY, MALAYSIA, MEXICO, NETHERLANDS, PERU, POLAND, REPUBLIC OF KOREA, ROMANIA, RUSSIA, SINGAPORE, SPAIN, SWITZERLAND, TAIWAN, THAILAND, TUNISIA, TURKEY, USA, VIETNAM

KOBOLD Messring GmbH  
Nordring 22-24  
D-65719 Hofheim/Ts.  
Head Office:  
+49(0)6192 299-0  
+49(0)6192 23398  
info.de@kobold.com  
www.kobold.com



## Magnetic Level Switches for Liquids Model KIT-S1

### Design



### Description

Magnetic level switches are used for the monitoring and control of liquid levels in vessels. Magnetic level switches are manufactured to customer specification.

An overview of types available with minimum lengths of guide tube is set out on the following pages. Please refer to this overview when placing your order. Furthermore, any limits can be specified within the limits found in the brochure.

For example:

- Longer guidetube
- Longer connection cable
- Different cable materials
- Different materials

### Method of Operation

Kobold magnetic float switches are fitted with a hermetically sealed contact which is situated in the tube.

The float sliding on the tube contains a ring magnet whose magnetic field switches the sealed contact in a non-contacting fashion. The sealed contacts are available as N/O, N/C or changeover contacts.

The float sliding up and down on the liquid is the only moving part in the Kobold magnetic float switches.

### Advantages

- Simple installation
- Long electrical service life due to sealed contacts
- High-degree of operational reliability with air gap between guide tube and floats
- Installation in top or bottom of vessel
- Open/close function or changeover contact available

### Model KIT-S1

#### Guide tube and process connection material

**S** = stainless steel 1.4401  
**O** = brass  
**V** = PVC  
**F** = PVDF

#### Process connection size

**06** = 1/8"  
**08** = 1/4"  
**10** = 3/8"

#### Process connection thread

**G** = Gas parallel (UNI 228/1)  
**C** = Gas conical (UNI7/1)\*  
**N** = Conical NPT\*

\*on request

#### Contact operation\* (separately wired)

**I1** = N/O contact,  
**I2** = N/C contact  
**I3** = changeover contact

#### Contact types

**3** = SPST, (300-350 V<sub>AC/DC</sub> / 0.5-0.7 A / 70 VA)  
**4** = SPST, (250 V<sub>AC/DC</sub> / 1.3 A / 80 VA)  
**7** = changeover contact, (230 V<sub>AC/DC</sub> / 1 A / 60 VA)  
**7D** = changeover contact, (150 V<sub>AC/DC</sub> / 0.5 A / 20 VA)

#### Electr. connection

**C1** = 1.5 m PVC-cable  
**C2** = 3 m PVC-cable  
**YY** = special length and type

#### ATEX

Available on request

#### \*Please note:

Contact operation refers to a no-level condition. The position of the contact, measured from the sealing edge of the connection screwing, must also be specified.

Guide tube length is designated as L0 (see dimensional drawings)

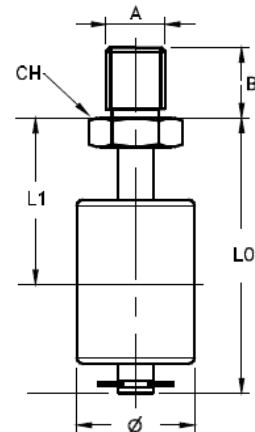



## Float designs

Model	Form	Materials	Float outside Ø [mm]	Contact type	Guide tube material*	S.G.	Process connect. type	Max. temperature	Nominal pressure at 20 °C
B20	Cylinder	SPANSIL	30	3, 7D	Nickel Plated Brass	> 0.4	06	L=105 °C	20 bar
B28	Cylinder	SPANSIL	20	3	Brass	> 0.4	06	L=105 °C	20 bar
B44	Cylinder	SPANSIL	44	4, 7	Brass	> 0.45	08	L=105 °C	20 bar
B45	Cylinder	SPANSIL	30	4, 7	Nickel Plated Brass	> 0.35	06	L=105 °C	20 bar
F25	Cylinder	PVDF	25	3	PVDF	> 0.65	06	N=130 °C	6 bar
P20	Cylinder	PP	20	3	PVC	> 0.5	06	D=90 °C	3 bar
V49	Cylinder	PVC	49	4, 7	PVC	> 0.7	10	B=60 °C	6 bar
F49	Cylinder	PVDF	49	4, 7	PVDF	> 0.8	10	N=130 °C	6 bar
S28	Cylinder	Stainless steel 1.4401	28	3, 7D	Stainless steel 1.4401	> 0.8	06	L=105 °C	10 bar
S29	Cylinder	Stainless steel 1.4401	30	3, 7D	Stainless steel 1.4401	> 0.75	06	L=105 °C	30 bar
S41	Cylinder	Stainless steel 1.4401	41	4, 7	Stainless steel 1.4401	> 0.65	08	L=105 °C	10 bar
S52	Ball	Stainless steel 1.4401	52	4, 7	Stainless steel 1.4401	> 0.7	08	L=105 °C	50 bar
S100	Ball	Stainless steel 1.4401	100	7	Stainless steel 1.4401	> 0.6	10	L=105 °C	15 bar

\*Other materials on request.

## Mounting instructions

Float switches can also be fitted in the bottom of vessels.

*Important: The contact operation is then reversed.*



## Level Switches Model KIT-S1 Floats

### Spansil series

Dimensions [mm]

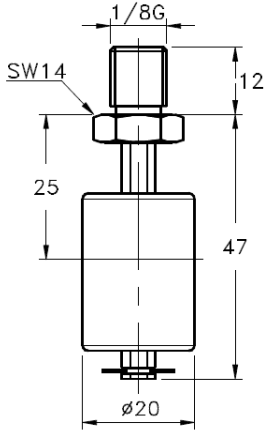

**B28**

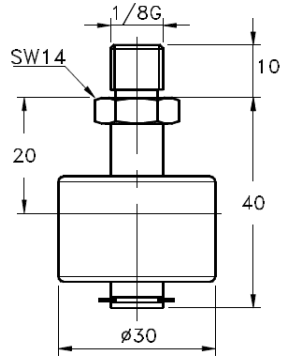

**B20**

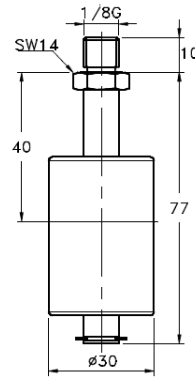

**B45**

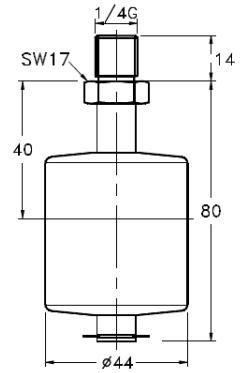

**B44**

### Plastic series

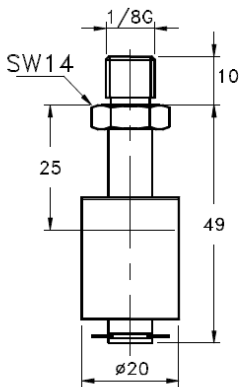

**P20**

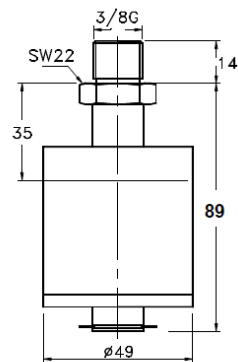

**V49**

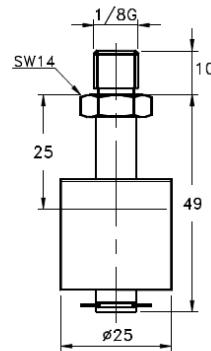

**F25**

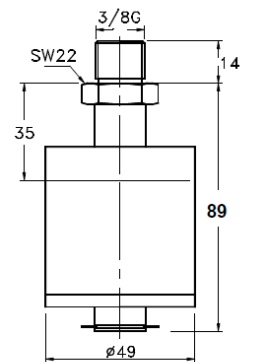

**F49**

### Stainless Steel series

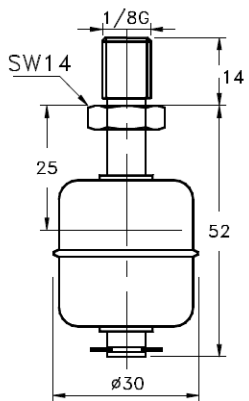

**S29**  
**S28 (Ø28)**

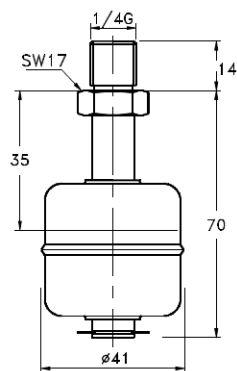

**S41**

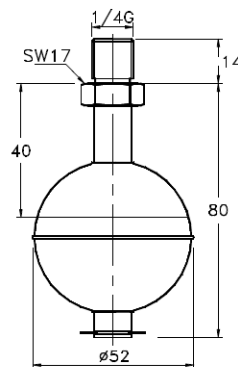

**S52**

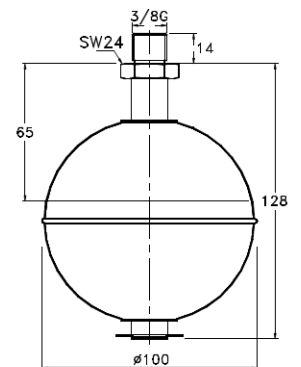

**S100**